



### Description

Gas Discharge Tube (GDT) is a single-gap or multi-gap switching overvoltage protection device. Under normal circumstances, the GDT is in a high-impedance state; when suffer a surge, the GDT will change from a high-impedance state to a low-impedance state, and release the surge energy to the ground, reducing the residual voltage of the circuit, thereby protecting the equipment circuit or protect the human body from the hazards of transient overvoltage. GDT is formed by high-temperature sealing of metal electrodes, metallized ceramics, inert gas or other mixed gases.

### Features

- Fast Response
- Stable Performance Over Surface Life
- High Current Rating
- Low Capacitance
- High Insulation Resistance
- RoHS & REACH Compliant

### Applications

- Telecom Equipment
- New Energy
- Power supply
- Irrigation System

### Agency Information

Agency Symbol	Standards	The File No. and certification No. obtained by SETsafe   SETfuse
	UL497B	E513446

### Dimensions (mm)



L	W	H	D	L <sub>2</sub>	d
5.0 ± 0.3	5.3 ± 0.2	5.3 ± 0.2	Φ5.0 ± 0.2	0.5 ± 0.2	Φ1.4

### Part Numbering System

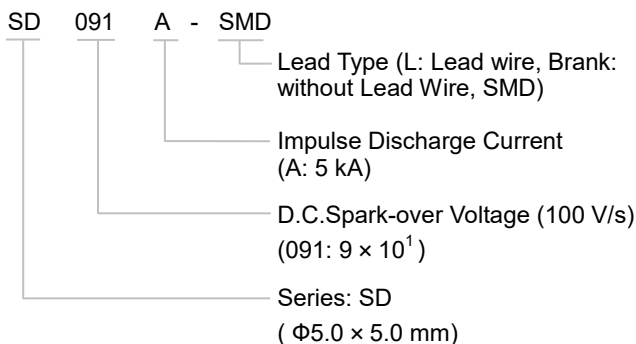

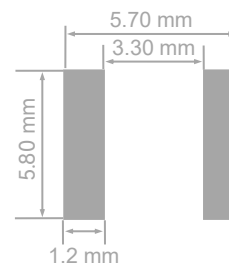

### Recommendation Pad Size (mm)



**Reminder:**

Part numbering system in the datasheet is only for selecting correct parameter and product features. Before placing order, please contact us for specifications and use the part number and product code in the specifications to place order to ensure the part is correct. Product code is the unique identification.

**Specifications**

Model	D.C. Spark-over Voltage @100 V/s	Tolerance of $V_s$	Impulse Spark-over Voltage @1 kV/ $\mu$ s	Arc Voltage @0.5 A	Impulse Discharge Current @8/20 $\mu$ s	Alternating Discharge Current @50Hz 1 s	Insulation Resistance		Capacitance 0.5 VDC @ 1MHz	Agency Approvals	
	$V_s$	$V_s$	V	$V_a$	$I_n$	$I$	VDC	IR	C		
	V	V	V	V	kA	A (r.m.s.)	V	G $\Omega$	(pF)	UL497B	TUV
SD071A - SMD	70	52 ~ 88	$\leq 650$	$\approx 8$	5	5	25	$\geq 1$	$\leq 1.0$	●	○
SD075A - SMD	75	57 ~ 93	$\leq 650$	$\approx 8$	5	5	25	$\geq 1$	$\leq 1.0$	●	○
SD091A - SMD	90	72 ~ 108	$\leq 600$	$\approx 8$	5	5	50	$\geq 1$	$\leq 1.0$	●	○
SD151A - SMD	150	120 ~ 180	$\leq 600$	$\approx 10$	5	5	50	$\geq 1$	$\leq 1.0$	●	○
SD231A - SMD	230	184 ~ 276	$\leq 700$	$\approx 12$	5	5	100	$\geq 1$	$\leq 1.0$	●	○
SD251A - SMD	250	200 ~ 300	$\leq 800$	$\approx 12$	5	5	100	$\geq 1$	$\leq 1.0$	●	○
SD351A - SMD	350	280 ~ 420	$\leq 1000$	$\approx 12$	5	5	100	$\geq 1$	$\leq 1.0$	●	○
SD421A - SMD	420	336 ~ 504	$\leq 1000$	$\approx 15$	5	5	100	$\geq 1$	$\leq 1.0$	●	○
SD471A - SMD	470	376 ~ 564	$\leq 1200$	$\approx 15$	5	5	100	$\geq 1$	$\leq 1.0$	●	○
SD601A - SMD	600	480 ~ 720	$\leq 1400$	$\approx 15$	5	5	100	$\geq 1$	$\leq 1.0$	●	○
SD801A - SMD	800	640 ~ 960	$\leq 1600$	$\approx 15$	5	5	100	$\geq 1$	$\leq 1.0$	●	○

Note:

1. The above parameters based on ITU - T K12 & IEC61643.311 standards.
2. "●" means GDT has gained the certification. "○" means GDT is no certification.
3. Operating Temperature -40 °C ~ +125 °C .

**Electrical Characteristics**

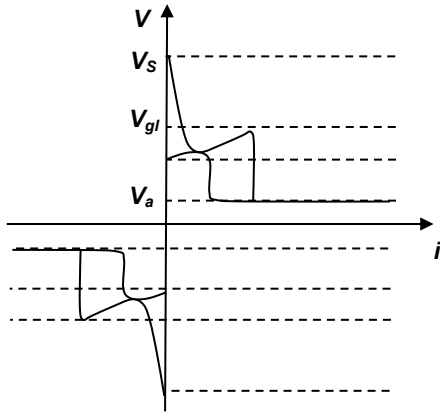

Relationship between Current and Voltage

- $V_s$  : Spark-over Voltage
- $V_{gl}$  : Glow Voltage
- $V_a$  : Arc Voltage
- G : Glow Mode
- A : Arc Mode

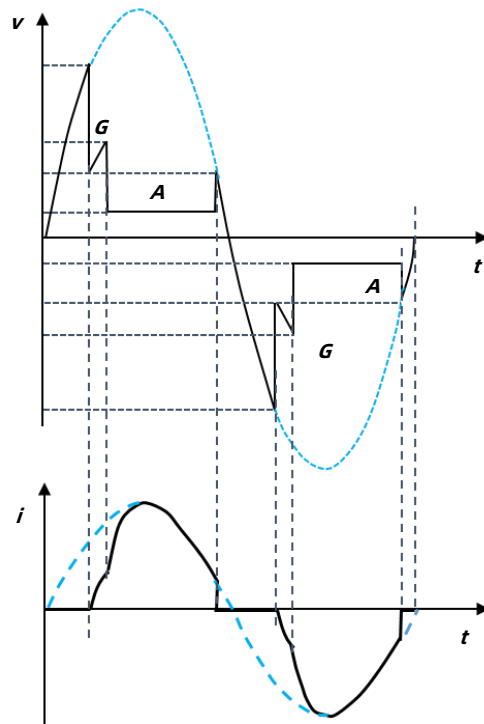

Time Variation Patterns of Voltage and Current

**Reference Curve for Spark-over Voltage (Refer to 230 VDC)**



**Curve for Impulse Discharge Current (For Reference Only)**

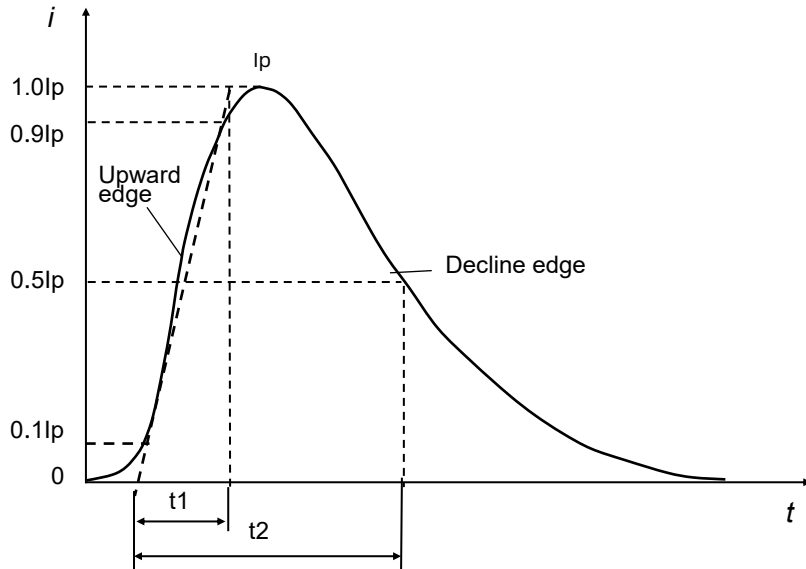

$I_p$ : Peak current  
 $t_1$ : Rise time in  $\mu s$   
 $t_2$ : Delay time to half value in  $\mu s$

**Application Example (For Reference Only)**

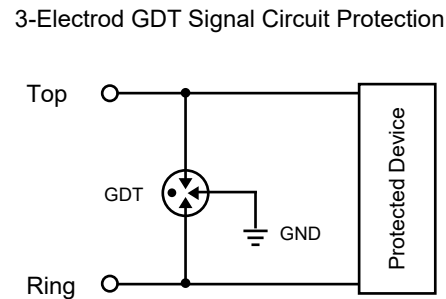
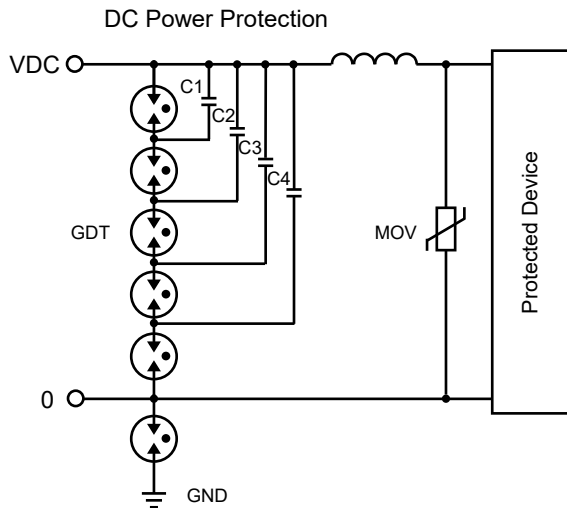
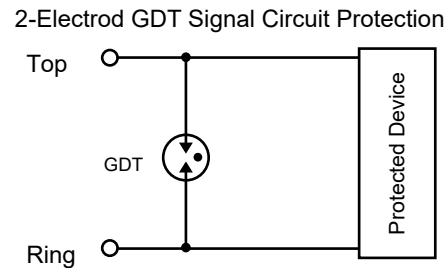
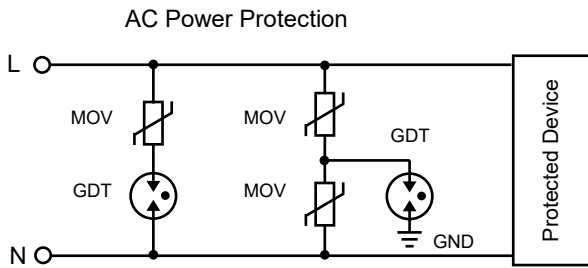

**Reflow Soldering Parameters (For Reference Only)**

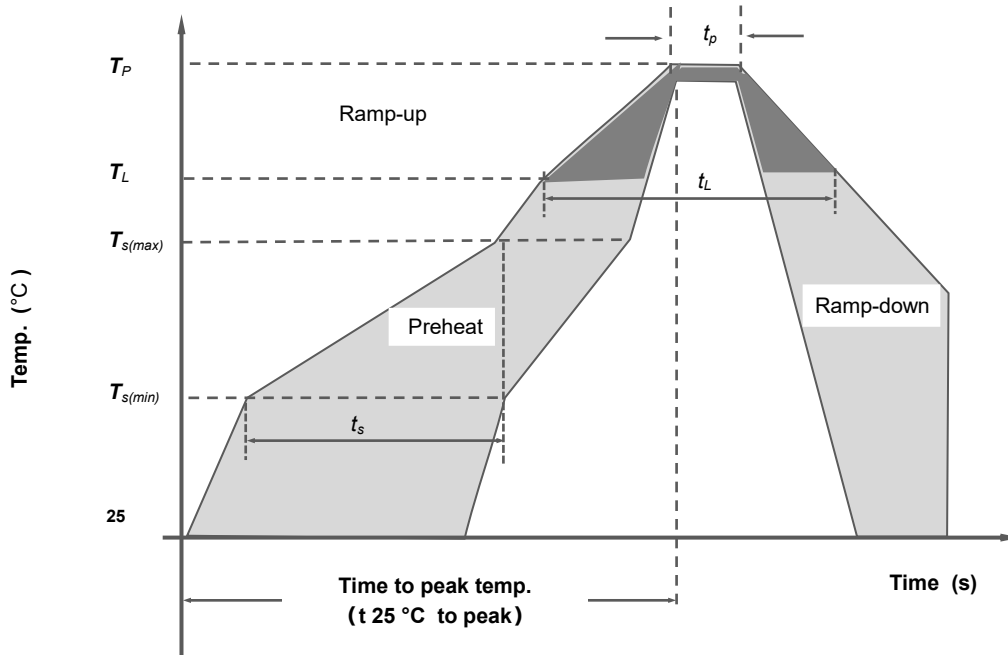

Reflow Condition		Pb-Free Assembly
Preheat	Temp. Min $T_{s(min)}$	150 °C
	Temp. Max $T_{s(max)}$	200 °C
	Time (Min to Max) $t_s$	(60 to 180) s
Average ramp up rate (Liquidus Temp. ( $T_L$ ) to peak)		3 °C / second max
$T_{s(max)}$ to $T_L$ Ramp-up Rate		5 °C / second max
Reflow	Temp. ( $T_L$ ) (Liquidus)	217 °C
	Temp. ( $t_L$ )	(60 to 150) s
Peak Temp. ( $T_P$ )		(255 to 260) °C
Time within 5 °C of actual peak Temp. ( $t_p$ )		(10 to 30) s
Ramp-down Rate		6 °C / second max
Time 25 °C to peak Temp. ( $T_P$ )		8 minutes max
Do not exceed		260 °C

## Packaging Information

### Tape & Reel (SMD)

Item	Reel	Inner Box	Carton
Dimensions (mm)	Φ330 × 20.5	340 × 340 × 40	360 × 360 × 360
Quantity (PCS)	1000	2000	14000
Notes: Packaging dimensions and quantity are for reference only.			



## Glossary

Item	Description
$V_s$	<p><b>D.C. Spark-over Voltage</b></p> <p>The voltage at which the GDT sparks over with slowly increasing d.c. voltage.</p> <p>— (IEC 61643-311)</p>
$V$	<p><b>Impulse Spark-over Voltage</b></p> <p>The highest Voltage which appears across the terminals of a GDT in the period between the application of an impulse of given wave-shape and the time when current begins to flow.</p> <p>— (ITU-T K.12)</p>
$V_a$	<p><b>Arc Voltage</b></p> <p>Voltage drop across the GDT during arc current flow.</p> <p>— (IEC 61643-311)</p>
$V_{gl}$	<p><b>Glow Voltage</b></p> <p>The peak value of the voltage drop across the GDT when a glow-current is flowing, It is sometimes called the glow mode voltage.</p> <p>— (ITU-T K.12)</p>
<b>8/20 <math>\mu</math>s</b>	<p><b>8/20 Current Impulse</b></p> <p>Current impulse with a nominal virtual front time of 8 <math>\mu</math>s and a nominal time to half-value of 20 <math>\mu</math>s.</p> <p>— (IEC 61643-11)</p>
<b>1.2/50 <math>\mu</math>s</b>	<p><b>1.2/50 Voltage Impulse</b></p> <p>Voltage impulse with a nominal virtual front time of 1.2 <math>\mu</math>s and a nominal time to half-value of 50 <math>\mu</math>s.</p> <p>— (IEC 61643-11)</p>
$I$	<p><b>Alternating Discharge Current</b></p> <p>The r.m.s. value of an approximately sinusoidal alternating current passing through the GDT.</p> <p>— (ITU-T K.12)</p>
$I_n$	<p><b>Nominal Discharge Current</b></p> <p>Crest value of the current through the GDT having a current waveshape of 8/20 <math>\mu</math>s.</p> <p>— (IEC 61643-11)</p>
$I_{max}$	<p><b>Maximum Discharge Current</b></p> <p>Crest value of a current through the GDT having an 8/20 <math>\mu</math>s waveshape and magnitude according to the manufacturers specification. <math>I_{max}</math> is equal to or greater than <math>I_n</math>.</p> <p>— (IEC 61643-11)</p>



# ATTENTION

## Usage

1. Do not operate GDT in power supply networks, whose maximum operation voltage exceeds the minimum spark-overvoltage of the GDT.
2. The GDT may become hot in the event of longer periods of current stress (burn risk). In the event of overload the connectors may fail or the component may be destroyed.
3. If the contacts of GDT are defective, current load can cause sparks and loud noises.
4. When air pressure is from 55 kPa to 106 kPa. The relative altitude shall be +5000 m to -500 m.

## Replacement

The GDT is a non-repairable product. For safety sake, please use equivalent GDT for replacement.

## Storage

The packaged GDT should be placed in a dry, ventilation and non-corrosive environment.

## Installation Position

Do not install the GDT in a touchable position.

## Mechanical Stress

Do not take violent action such as knocking when assembling, to avoid product failure.

**Gas Discharge Tube (GDT) Features & Model List Overview**

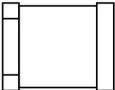
DC Spark-over Voltage (V)	Model								
	SE (-SMD)	SE (-SMD)	SE (-SMD)	SE (-SMD)	SE (-SMD)	SE (-SMD)	SE (-SMD)	SE (-SMD)	SE (-SMD)
4500	○	○	○	○	○	○	○	○	SE (-SMD)
4000	○	○	○	○	○	○	○	○	SE (-SMD)
3600	○	○	○	○	○	○	○	○	SE (-SMD)
3000	○	○	○	○	○	○	○	○	SE (-SMD)
2500	○	○	○	○	○	○	○	○	SE (-SMD)
2000	○	○	○	○	○	○	○	○	SE (-SMD)
1500	○	○	○	○	○	○	○	○	SE (-SMD)
1200	○	○	○	○	○	○	○	○	SE (-SMD)
1000	○	○	○	○	○	○	○	○	SE (-SMD)
800	○	SW (-SMD)	SX (-SMD)	SY (-SMD)	SN (-SMD)	SU (-SMD)	SS (-SMD)	SD (-SMD)	SE (-SMD)
600	○	SW (-SMD)	SX (-SMD)	SY (-SMD)	SN (-SMD)	SU (-SMD)	SS (-SMD)	SD (-SMD)	SE (-SMD)
470	○	SW (-SMD)	SX (-SMD)	SY (-SMD)	SN (-SMD)	SU (-SMD)	SS (-SMD)	SD (-SMD)	SE (-SMD)
420	○	SW (-SMD)	SX (-SMD)	SY (-SMD)	SN (-SMD)	SU (-SMD)	SS (-SMD)	SD (-SMD)	SE (-SMD)
400	SZ (-SMD)	SW (-SMD)	SX (-SMD)	SY (-SMD)	SN (-SMD)	○	○	○	○
350	○	SW (-SMD)	SX (-SMD)	SY (-SMD)	SN (-SMD)	SU (-SMD)	SS (-SMD)	SD (-SMD)	SE (-SMD)
300	SZ (-SMD)	SW (-SMD)	SX (-SMD)	SY (-SMD)	SN (-SMD)	○	○	○	○
250	○	○	○	○	○	SU (-SMD)	SS (-SMD)	SD (-SMD)	SE (-SMD)
230	SZ (-SMD)	SW (-SMD)	SX (-SMD)	SY (-SMD)	SN (-SMD)	SU (-SMD)	SS (-SMD)	SD (-SMD)	SE (-SMD)
200	SZ (-SMD)	SW (-SMD)	SX (-SMD)	SY (-SMD)	SN (-SMD)	○	○	○	○
150	SZ (-SMD)	SW (-SMD)	SX (-SMD)	SY (-SMD)	SN (-SMD)	SU (-SMD)	SS (-SMD)	SD (-SMD)	SE (-SMD)
90	SZ (-SMD)	SW (-SMD)	SX (-SMD)	SY (-SMD)	SN (-SMD)	SU (-SMD)	SS (-SMD)	SD (-SMD)	SE (-SMD)
75	○	SW (-SMD)	SX (-SMD)	SY (-SMD)	SN (-SMD)	○	SS (-SMD)	SD (-SMD)	SE (-SMD)
70	○	○	○	○	SN (-SMD)	○	SS (-SMD)	SD (-SMD)	SE (-SMD)
<b>Size ( mm )</b>	3.2 × 1.6 × 1.6	3.2 × 2.5 × 2.5	4.5 × 3.2 × 2.7	4.0 × 3.5 × 3.5	4.2 × 5.0 × 5.0	5.0 × 5.4 × 5.4	4.2 × 6.2 × 6.2	5.0 × 5.4 × 5.4	6.0 × 8.3 × 8.3
<b>I<sub>n</sub> ( 8/20 μs ) (kA)</b> Impulse Discharge Current	0.5	1	1 / 2	3	5	5 / 10	5	5	5 / 10 / 20
<b>Product Structure</b>									
						SMD			

**Gas Discharge Tube (GDT) Features & Model List Overview**

DC Spark-over Voltage (V)	Model						
	SK (-SMD)	SC (-SMD)	SF (-SMD)	TS (-SMD)	TZ (-SMD)	TY (-SMD)	TR (-SMD)
4500	○	○	SF (-SMD)	○	○	○	○
4000	○	○	SF (-SMD)	○	○	○	○
3600	○	○	SF (-SMD)	○	○	○	○
3000	○	○	SF (-SMD)	○	○	○	○
2500	○	○	SF (-SMD)	○	○	○	○
2000	○	○	SF (-SMD)	○	○	○	○
1500	○	○	SF (-SMD)	○	○	○	○
1200	○	○	SF (-SMD)	○	○	○	○
1000	SK (-SMD)	○	SF (-SMD)	○	○	○	○
800	SK (-SMD)	SC (-SMD)	SF (-SMD)	○	○	○	○
600	SK (-SMD)	SC (-SMD)	SF (-SMD)	TS (-SMD)	TZ (-SMD)	TY (-SMD)	TR (-SMD)
470	○	SC (-SMD)	SF (-SMD)	TS (-SMD)	TZ (-SMD)	○	TR (-SMD)
420	SK (-SMD)	SC (-SMD)	SF (-SMD)	TS (-SMD)	TZ (-SMD)	TY (-SMD)	TR (-SMD)
400	○	○	○	○	○	○	○
350	SK (-SMD)	SC (-SMD)	SF (-SMD)	○	TZ (-SMD)	TY (-SMD)	TR (-SMD)
300	○	○	○	TS (-SMD)	○	○	○
250	○	SC (-SMD)	SF (-SMD)	○	○	TY (-SMD)	○
230	○	SC (-SMD)	SF (-SMD)	TS (-SMD)	TZ (-SMD)	TY (-SMD)	TR (-SMD)
200	○	○	○	TS (-SMD)	TZ (-SMD)	○	○
150	○	SC (-SMD)	SF (-SMD)	TS (-SMD)	TZ (-SMD)	○	TR (-SMD)
90	SK (-SMD)	SC (-SMD)	SF (-SMD)	TS (-SMD)	TZ (-SMD)	○	TR (-SMD)
75	○	SC (-SMD)	SF (-SMD)	○	TZ (-SMD)	○	○
70	○	SC (-SMD)	SF (-SMD)	○	○	○	○
<b>Size ( mm )</b>	Φ8.0 × 2.2	6.0 × 8.3 × 8.3	6.0 × 6.0 × 6.0	6.8 × 3.5 × 3.5	7.6 × 5.0 × 5.0	7.8 × 5.0 × 5.0	10.0 × 8.3 × 8.3
<b>I<sub>n</sub> ( 8/20 μs ) (kA)</b> Impulse Discharge Current	10 / 20	20	3 / 5 / 10	3	5 / 10	5	10 / 20
<b>Product Structure</b>							
				SMD			

**Gas Discharge Tube (GDT) Features & Model List Overview**

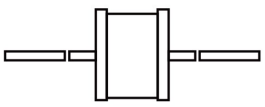
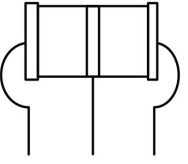
DC Spark-over Voltage (V)	Model					
	SD (-L)	SF (-L)	SE (-L)	TZ (-L)	TB (-L)	TR (-L)
4500		SF (-L)	SE (-L)			
4000		SF (-L)	SE (-L)			
3600		SF (-L)	SE (-L)			
3000		SF (-L)	SE (-L)			
2500		SF (-L)	SE (-L)			
2000		SF (-L)	SE (-L)			
1500		SF (-L)	SE (-L)			
1200			SE (-L)			
1000		SF (-L)	SE (-L)			
800	SD (-L)	SF (-L)	SE (-L)			
600	SD (-L)	SF (-L)	SE (-L)	TZ (-L)	TB (-L)	TR (-L)
470	SD (-L)	SF (-L)	SE (-L)	TZ (-L)	TB (-L)	TR (-L)
420	SD (-L)	SF (-L)	SE (-L)	TZ (-L)	TB (-L)	TR (-L)
400						
350	SD (-L)	SF (-L)	SE (-L)	TZ (-L)	TB (-L)	TR (-L)
300						
250	SD (-L)	SF (-L)	SE (-L)			
230	SD (-L)	SF (-L)	SE (-L)	TZ (-L)	TB (-L)	TR (-L)
200				TZ (-L)		
150	SD (-L)	SF (-L)	SE (-L)	TZ (-L)	TB (-L)	TR (-L)
90	SD (-L)	SF (-L)	SE (-L)	TZ (-L)	TB (-L)	TR (-L)
75	SD (-L)	SF (-L)	SE (-L)	TZ (-L)		
70	SD (-L)	SF (-L)	SE (-L)			
<b>Size ( mm )</b>	$\Phi 5.0 \times 5.0$	$\Phi 5.5 \times 6.0$	$\Phi 8.0 \times 6.0$	$\Phi 5.0 \times 7.6$	$\Phi 6.0 \times 8.2$	$\Phi 8.0 \times 10.0$
<b><math>I_n</math> ( 8/20 <math>\mu</math>s ) (kA)</b> Impulse Discharge Current	5	3 / 5 / 10	5 / 10 / 20	5 / 10	10	10 / 20
<b>Product Structure</b>				DIP		

**Gas Discharge Tube (GDT) Features & Model List Overview**

<b>DC Spark-over Voltage (V)</b>	4500	○	○	○	○	○	○	○	○	○	○	○	○	○	○
	4000	○	○	○	○	○	○	○	○	○	○	○	○	○	○
	3600	○	○	○	○	○	○	○	○	○	○	○	○	○	○
	3000	○	○	○	○	○	○	○	○	SPR	○	○	○	○	○
	2500	○	○	○	○	○	○	○	○	○	○	○	○	○	○
	2000	○	SPB	○	○	○	○	○	○	SPR	○	○	○	○	○
	1500	SPA	SPB	○	SPJ	SPI	○	○	○	○	○	○	○	○	○
	1400	○	○	○	○	○	○	○	○	○	○	○	○	○	TPA
	1000	○	SPB	SPC	SPJ	○	○	○	○	○	○	○	○	○	○
	800	SPA	SPB	SPC	SPJ	SPI	SPH	SPK	SPP	SPR	SPS	SPV	SPZ	SPO	TPA
	600	SPA	SPB	SPC	SPJ	SPI	SPH	SPK	SPP	SPR	SPS	SPV	SPZ	SPO	○
	470	○	○	○	○	○	○	○	○	○	○	○	○	○	○
	420	○	○	○	○	○	○	○	○	○	○	○	○	○	○
	400	○	○	○	○	○	○	○	○	○	○	○	○	○	○
	350	SPA	SPB	SPC	SPJ	SPI	SPH	○	○	○	○	SPV	SPZ	○	○
300	○	○	○	○	○	○	○	○	○	○	○	○	○	○	
250	○	○	○	○	○	○	○	○	○	○	○	○	○	○	
230	○	○	○	○	○	○	○	○	○	○	○	○	○	○	
200	○	○	○	○	○	○	○	○	○	○	○	○	○	○	
150	○	SPB	○	○	○	○	○	○	○	○	○	○	○	○	
90	○	SPB	○	○	○	○	○	SPK	○	○	○	○	○	○	
75	○	○	○	○	○	○	○	○	○	○	○	○	○	○	
70	○	○	○	○	○	○	○	○	○	○	○	○	○	○	
<b>Size ( mm )</b>	Φ11.8 × 16.0	Φ11.8 × 6.2	Φ11.8 × 4.2	Φ16.0 × 4.5	Φ16.0 × 8.0	Φ18.0 × 6.7	Φ15.0 × 3.0	Φ30.0 × 12.0	Φ20.0 × 6.0	Φ24.0 × 10.0	Φ20.0 × 4.0	Φ11.8 × 12.0	Φ30.0 × 30.0	16 × 8.4 × 9.3	
<b>I<sub>n</sub> ( 8/20 μs ) (kA)</b> Impulse Discharge Current	20 / 30 / 40	20	20 / 30	20 / 30 / 40	30	40	25 / 50 / 100	20 / 40	80	40	20 / 40	100	20		
<b>Product Structure</b>															

High Current  
(May increase each kind of connect mode according to the customer different demand.)